

<b>DE</b>	Gebruiksaanleitung / Montageanleitung	<b>2</b>
<b>FR</b>	Mode d'emploi / Instructions de montage	<b>2</b>
<b>EN</b>	Instructions for use / assembly instructions	<b>3</b>
<b>IT</b>	Istruzioni per l'uso / Istruzioni per Installazione	<b>3</b>
<b>ES</b>	Modo de empleo / Instrucciones de montaje	<b>4</b>
<b>NL</b>	Gebruiksaanwijzing / Handleiding	<b>4</b>
<b>DK</b>	Brugsanvisning / Monteringsvejledning	<b>5</b>
<b>PT</b>	Instruções para uso / Manual de Instalação	<b>5</b>
<b>PL</b>	Instrukcja obsługi / Instrukcja montażu	<b>6</b>
<b>CS</b>	Návod k použití / Montážní návod	<b>6</b>
<b>SK</b>	Návod na použitie / Montážny návod	<b>7</b>
<b>ZH</b>	用户手册 / 组装说明	<b>7</b>
<b>RU</b>	Руководство пользователя / Инструкция по монтажу	<b>8</b>
<b>HU</b>	Használati útmutató / Szerelési útmutató	<b>8</b>
<b>FI</b>	Käyttöohje / Asennusohje	<b>9</b>
<b>SV</b>	Bruksanvisning / Monteringsanvisning	<b>9</b>
<b>LT</b>	Vartotojo instrukcija / Montavimo instrukcijos	<b>10</b>
<b>HR</b>	Upute za uporabu / Uputstva za instalaciju	<b>10</b>
<b>TR</b>	Kullanım kılavuzu / Montaj kılavuzu	<b>11</b>
<b>RO</b>	Manual de utilizare / Instrucțiuni de montare	<b>11</b>
<b>EL</b>	Οδηγίες χρήσης / Οδηγία συναρμολόγησης	<b>12</b>
<b>SL</b>	Navodilo za uporabo / Navodila za montažo	<b>12</b>
<b>ET</b>	Kasutusjuhend / Paigaldusjuhend	<b>13</b>
<b>LV</b>	Lietošanas pamācība / Montāžas instrukcija	<b>13</b>
<b>SR</b>	Uputstvo za upotrebu / Uputstvo za montažu	<b>14</b>
<b>NO</b>	Bruksanvisning / Montasjeveiledning	<b>14</b>
<b>BG</b>	Инструкция за употреба / Ръководство за монтаж	<b>15</b>
<b>SQ</b>	Udhëzuesi i përdorimit / Udhëzime rreth montimit	<b>15</b>
<b>AR</b>	دليل الاستخدام / تعليمات التجميع	<b>16</b>

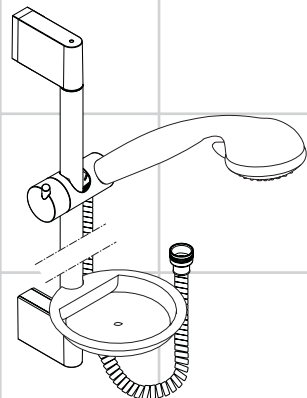

**Unica'Crometta**  
27609000

**Unica'Crometta**  
27614000 / 27615000

**Crometta 85 1jet/  
Unica'Crometta Set**  
27728000 / 27729000



## Sicherheitshinweise

- Bei der Montage müssen zur Vermeidung von Quetsch- und Schnittverletzungen Handschuhe getragen werden.
- Das Produkt darf nicht als Haltegriff benutzt werden. Es muss ein separater Haltegriff montiert werden.
- Brausenschläuche sind nur zum Anschluss von Brausen an Armaturen geeignet. Eine Absperrung nach dem Schlauch in Fließrichtung ist unzulässig!

## Montagehinweise

- Bei der Montage des Produktes durch qualifiziertes Fachpersonal ist darauf zu achten, dass die Befestigungsfläche im gesamten Bereich der Befestigung plan ist (keine vorstehenden Fugen oder Fliesenversatz), der Wandaufbau für eine Montage des Produktes geeignet ist und keine Schwachstellen aufweist. Die beigelegten Schrauben und Dübel sind nur für Beton geeignet. Bei anderen Wandaufbauten sind die Herstellerangaben des Dübelherstellers zu beachten.
- Optimale Funktion nur in Verbindung mit Hansgrohe Handbrausen und Hansgrohe Brausenschläuchen garantiert.
- Funktion und Bedienung der Handbrause siehe beiliegende Broschüre.

## Symbolerklärung



Kein essigsäurehaltiges Silikon verwenden!



**Maße** (siehe Seite 17)



**Bedienung** (siehe Seite 18)



**Reinigung**

siehe beiliegende Broschüre.



**Serviceteile** (siehe Seite 20)



**Prüfzeichen** (siehe Seite 20)

## Consignes de sécurité

- Lors du montage, porter des gants de protection pour éviter toute blessure par écrasement ou coupure.
- Le produit ne doit pas servir de poignée. Monter pour cela une poignée séparée.
- Les flexibles de douche ne doivent être utilisés que pour le raccordement d'une douche à main à un robinet. Le montage d'un système d'arrêt après le flexible, en direction du courant d'eau est strictement interdit.

## Instructions pour le montage

- Lors du montage du produit par un ouvrier qualifié, il faut faire attention à ce que la surface de fixation soit plane sur toute son étendue (aucun dépassement de joint ni de carrelage), que la construction de la paroi soit adaptée à l'installation du produit et surtout ne présente aucun point faible. Les vis et les chevilles fournies sont uniquement appropriées au béton. Pour les autres constructions, il faudra tenir compte des préconisations du fabricant de cheville.
- Un fonctionnement optimal est seulement garanti en combinaison avec des douches à main et des flexibles Hansgrohe.
- Pour le fonctionnement et la manipulation de la douche, voir la brochure ci-jointe.

## Description du symbole



Ne pas utiliser de silicone contenant de l'acide acétique!



**Dimensions** (voir page 17)



**Instructions de service** (voir page 18)



**Nettoyage**

voir la brochure ci-jointe.



**Pièces détachées** (voir pages 20)



**Classification acoustique et débit** (voir page 20)

**Montage**

**siehe Seite 19**





**Montage**

**voir page 19**



### Safety Notes

-  Gloves should be worn during installation to prevent crushing and cutting injuries.
-  The product may not be used as a holding handle. A separate handle must be installed.
-  Shower hoses are only suitable for a connection from the shower to the fitting. Never fit a shut-off device between the fitting and the hose.

### Installation Instructions

- Where the contractor mounts the product, he should ensure that the entire area of the wall to which the mounting plate is to be fitted, is flat (no projecting joints or tiles sticking out), that the structure of the wall is suitable for the installation of the product and has no weak points. The enclosed screws and dowels are only suitable for concrete. For another wall constructions the manufacturer's indications of the dowel manufacturer have to be taken into account.
- Optimal functioning is only guaranteed with the combination of Hansgrohe hand showers and Hansgrohe shower hoses.
- Operation and function of hand shower, see enclosed brochure.

### Symbol description



Do not use silicone containing acetic acid!



**Dimensions** (see page 17)



**Operation** (see page 18)



**Cleaning**

see enclosed brochure.





**Spare parts** (see page 20)



**Test certificate** (see page 20)

**Assembly**  
see page 19

### Indicazioni sulla sicurezza

-  Durante il montaggio, per evitare ferite da schiacciamento e da taglio bisogna indossare guanti protettivi.
-  Il prodotto non deve essere utilizzato come maniglia, questa deve essere montata separatamente.
-  I flessibili devono essere inseriti solo tra l'uscita dell'acqua e la doccetta. Non deve essere introdotta alcuna prolunga tra il flessibile e l'uscita dell'acqua.

### Istruzioni per il montaggio

- Quando il personale tecnico specializzato esegue il montaggio del prodotto è necessario assicurarsi che la superficie di fissaggio sia piana in tutta l'area di fissaggio (senza giunti sporgenti o spostamento delle piastrelle), che la struttura della parete sia adatta per il montaggio del prodotto e soprattutto che non ci siano dei punti deboli. Le viti e i tasselli in dotazione sono adatti solo per calcestruzzo. In caso di altre strutture della parete vanno osservare le indicazioni del produttore dei tasselli.
- Funzionalità ottimale solamente in combinazione con doccette e flessibili Hansgrohe.
- Funzionamento ed uso della doccia: vedi il prospetto accluso.

### Descrizione simbolo



Non utilizzare silicone contenente acido acetico!



**Ingombri** (vedi pagg. 17)



**Procedura** (vedi pagg. 18)



**Pulitura**

vedi il prospetto accluso.



**Parti di ricambio** (vedi pagg. 20)



**Segno di verifica** (vedi pagg. 20)



**Montaggio**  
vedi pagg. 19



## Indicaciones de seguridad

- ⚠ Durante el montaje deben utilizarse guantes para evitar heridas por aplastamiento o corte.
- ⚠ El producto no debe ser utilizado como un elemento de sujeción. Debe montarse un elemento de sujeción separado.
- ⚠ Los flexos deben usarse exclusivamente para la conexión entre grifería y teleducha. Cualquier función de cierre tras el flexo y en la dirección del flujo del agua no está permitida.

## Indicaciones para el montaje

- En el momento del montaje del producto por parte de personal especializado y cualificado se deberá prestar una atención especial a que la superficie de fijación en toda el área de la fijación sea plana (sin juntas que sobresalen ni azulejos desplazados), que la estructura de la pared sea adecuada para un montaje del producto y que, ante todo, no presente puntos débiles. Los tornillos y tacos adjuntos son sólo apropiados para hormigón. En el caso de otras estructuras murales se deberán considerar las indicaciones del fabricante de tacos.
- Sólo se garantiza una función óptima en combinación con teleduchas y flexos de Hansgrohe.
- Funcionamiento y manejo de la teleducha: véase el folleto adjunto.

## Descripción de símbolos



No utilizar silicona que contiene ácido acético!



**Dimensiones** (ver página 17)



**Manejo** (ver página 18)



**Limpiar**

ver el folleto adjunto.



**Repuestos** (ver página 20)



**Marca de verificación** (ver página 20)

## Veiligheidsinstructies

- ⚠ Bij de montage moeten ter voorkoming van knel- en snijwonden handschoenen worden gedragen.
- ⚠ Het product mag niet als handgreep worden gebruikt. Er moet een aparte handgreep gemonteerd worden.
- ⚠ De doucheslangen zijn alleen geschikt voor de aansluiting van douches aan kranen. Een versperring ná de doucheslang in de stroomrichting is niet toelaatbaar.

## Montage-instructies

- Bij de montage van het produkt door een vakkundige installateur moet men erop letten dat het bevestigingsoppervlak op één oppervlak zit (dus geen opliggende voegen of verspringende tegels), de wand geschikt is voor montage van produkten en zeker geen zwakke plekken bevat. De bijgevoegde schroeven en duvels zijn alleen geschikt voor beton. Bei andere wandsoorten dient u te letten op de voorschriften van de fabrikant van de schroeven en duvels.
- Optimal funktionieren gegarandeerd bij combinatie met Hansgrohe handdouche en doucheslang.
- Functies en bediening van de handdouche, zie bijgevoegde brochure.

## Symbolbeschrijving



Gebruik geen zuurhoudende silicone!



**Maten** (zie blz. 17)



**Bediening** (zie blz. 18)



**Reinigen**

zie bijgevoegde brochure.



**Service onderdelen** (zie blz. 20)





**Keurmerk** (zie blz. 20)



**Montage**  
zie blz. 19



### Sikkerhedsanvisninger

-  Ved monteringen skal der bruges handsker for at undgå kvæstelser og snitsår.
-  Produktet må ikke bruges som håndtag. Der skal monteres et separat håndtag.
-  Bruserslanger bør kun anvendes i forbindelse med tilslutning mellem brusere og armatur. Det er ikke tilladt at montere en afspærringsventil mellem bruser og slange!

### Monteringsanvisninger



- Ved montering er det vigtigt at sikre sig, at hele befæstigelsesfladen er plan (ingen ujævne fuger eller fliser), samt at væggen er egnet til montering af produktet og specielt, at væggen ikke har nogen svage punkter. De medfølgende skrue og dübler er kun egnet til beton. Ved anden vægopbygning bør producenten af dübler kontaktes for nærmere information.
- Optimal funktion garanteres for anvendelse i forbindelse med Hansgrohe håndbrusere og Hansgrohe bruserslanger.
- Funktion og betjening af håndbruseren, se vedlagt brochure.

### Symbolbeskrivelse

-  Der må ikke benyttes eddikesyreholdig silikone!
-  **Målene** (se s. 17)
-  **Brugsanvisning** (se s. 18)
-  **Rengøring**  
se venligst den vedlagte brochure.
-  **Reserve dele** (se s. 20)
-  **Godkendelse** (se s. 20)

**Montering**  
se s. 19







### Avisos de segurança

-  Durante a montagem devem ser utilizadas luvas de protecção, de modo a evitar ferimentos resultantes de entalamentos e de cortes.
-  O produto não pode ser utilizado como pega de apoio. Tem que ser montada uma pega separada.
-  Os tubos flexíveis são apenas adequados para uma ligação do chuveiro à misturadora. Nunca instale uma válvula de corte entre a misturadora e o tubo flexível.

### Avisos de montagem

- Durante a montagem do produto por técnicos qualificados, deve ter-se em atenção que a superfície de fixação seja plana em toda a área da fixação (sem juntas sobrepostas/salientes ou ladrilhos deslocados), que o dispositivo de montagem na parede seja adequado para uma montagem na parede e que este não apresente nenhuns pontos fracos. Os parafusos e buchas incluídos no volume de fornecimento são apenas adequados para betão. Para outros métodos de montagem na parede devem ser respeitadas as indicações do fabricante das buchas.
- O bom funcionamento é apenas garantido em combinação com chuveiros de mão e tubos flexíveis Hansgrohe.
- Consultar o funcionamento e o manuseamento do chuveiro de mão na brochura em anexo.

### Descrição do símbolo



-  Não utilizar silicone que contenha ácido acético!
-  **Medidas** (ver página 17)
-  **Funcionamento** (ver página 18)
-  **Limpeza**  
consultar a seguinte brochura.
-  **Peças de substituição** (ver página 20)
-  **Marca de controlo** (ver página 20)

**Montagem**  
ver página 19





## Wskazówki bezpieczeństwa

-  Aby uniknąć zranień, takich jak zgniecenia czy przecięcia, podczas montażu należy nosić rękawice.
-  Produktu nie wolno używać jako uchwytu do trzymania się. Należy zamontować osobny uchwyt.
-  Wężę prysznicowe przeznaczone są do podłączenia tylko z armaturą. Blokada za wężem w kierunku przepływu jest niedopuszczalna.

## Wskazówki montażowe

- Przy montażu produktu przez wykwalifikowany personel fachowy należy zważać na to, by powierzchnia mocowania na całym obszarze mocowania była równa (by nie było szczelin wzgl. wzajemnie przesuniętych płytek), rodzaj ściany nadawał się do montażu produktu i zwłaszcza, by nie było żadnych słabych stron. Umieszczone w dostawie śruby i kołki rozporowe są przeznaczone tylko do betonu. Przy innych rodzajach montażu ściannowego należy przestrzegać danych producenta kołków rozporowych.
- Optymalne działanie gwarantuje się tylko w odniesieniu do pryszniców ręcznych i węży prysznicowych Hansgrohe.
- Funkcje i obsługa główki prysznicowej, opisana w dołożonej broszurze.

## Opis symbolu



Nie stosować silikonów zawierających kwas octowy!



**Wymiary** (patrz strona 17)



**Obsługa** (patrz strona 18)



**Czyszczenie**

patrz dołączona broszura.



**Części serwisowe** (patrz strona 20)





**Znak jakości** (patrz strona 20)

## Montaż

### patrz strona 19

## Bezpečnostní pokyny

-  Pro zabránění řezným zraněním a pohmožděním je nutné při montáži nosit rukavice.
-  Produkt nesmí být používán jako madlo. Je nutné namontovat samostatné madlo.
-  Sprchové hadice jsou vhodné pouze pro napojení sprch na armatury. Řazení uzavíracího ventilu za hadicí po směru toku je nepřipustné!

## Pokyny k montáži

- Při montáži produktu kvalifikovaným odborným personálem je třeba dbát na to, aby upevňovací plochy byly v celém rozsahu upevnění rovné (žádné vyčnívající spáry nebo navzájem přesazené obklady), aby konstrukce stěny byla pro montáž produktu vhodná a zvláště aby v ní nebyla žádná slabá místa. Přiložené vruty a hmoždinky jsou vhodné pouze pro beton. Při jiných konstrukčních materiálech stěny je třeba se řídit údaji výrobce hmoždinek.
- Optimální funkce je zaručena pouze s ručními sprchami a sprchovými hadicemi Hansgrohe.
- Funkce a ovládání ruční sprchy viz příložená brožura.

## Popis symbolů



Nepoužívat silikon s obsahem kyseliny octové!



**Rozměry** (viz strana 17)



**Ovládání** (viz strana 18)



**Čištění**

viz příložená brožura.



**Servisní díly** (viz strana 20)



**Zkušební značka** (viz strana 20)

## Montáž

### viz strona 19





## Bezpečnostné pokyny

- △ Pri montáži musíte nosiť rukavice, aby ste predišli pomliaždeninám a rezným poraneniam.
- △ Výrobok sa nesmie používať ako držadlo. K tomu účelu sa musí namontovať samostatné držadlo.
- △ Sprchové hadice sú vhodné iba pre napojenie spríchy na batérie. Umiestnenie uzatváracieho ventilu za hadicou v smere toku je neprípustné.

## Pokyny pre montáž

- Pri montáži produktu kvalifikovaným odborným personálom je nutné dbať na to, aby upevňovacie plochy boli v celom rozsahu upevnenia rovné (žiadne vyčnievajúce škáry alebo navzájom prešadené obklady), aby konštrukcia steny bola pre montáž produktu vhodná a zvlášť aby v nej neboli žiadne slabé miesta. Priložené vruty a hmoždinky sú vhodné len pre betón. Pri iných konštrukčných materiáloch steny je nutné riadiť sa údajmi výrobcu hmoždiniek.
- Optimálna funkcia je zaručená iba s ručnými sprchami a sprchovými hadicami Hansgrohe.
- Popis funkcie a ovládania ručnej sprchy nájdete v priloženej brožúre.

## Popis symbolov

 Nepoužívať silikón s obsahom kyseliny octovej!

 **Rozmery** (viď strana 17)

 **Obsluha** (viď strana 18)

 **Čistenie**  
nájdete v priloženej brožúre.

 **Servisné diely** (viď strana 20)

 **Osvedčenie o skúške** (viď strana 20)

**Montáž**  
**viď strana 19**



## 安全技巧

- △ 装配时为避免挤压和切割受伤，必须戴上手套。
- △ 该产品不得作扶柄使用。必须安装单独的扶柄。
- △ 淋浴软管只适合从淋浴器连接到管接头。切勿在管接头和软管之间安装截止装置。

## 安装提示

- 在安装产品的位置，安装人员必须确保安装面的墙面是平的（没有突出物或瓷砖没有突起），墙体结构适合产品的安装并没有弱点。包装内的膨胀螺丝只适用于混凝土墙体。对于其他墙体结构必须咨询膨胀螺丝生产商的建议。
- 只有与汉斯格雅手提花洒和汉斯格雅淋浴器软管组合使用，方担保最佳的功能。
- 手持花洒的功能和操作参见附入的小册子。

## 符号说明

 请勿使用含有乙酸的硅！

 大小 (参见第 17 页)

 操作 (参见第 18 页)

 清洗  
附有小手册



 备用零件 (参见第 20 页)

 检验标记 (参见第 20 页)

**安装**  
**参见第 19 页**



## **Указания по технике безопасности**

-  Во время монтажа следует надеть перчатки во избежание прищемления и порезов.
-  Изделие запрещается использовать в качестве рукоятки. Следует устанавливать специальную рукоятку.
-  Душевые шланги подходят только для подсоединения душей к арматуре. Не устанавливайте дополнительных затворов между шлангом и арматурой!

## **Указания по монтажу**

- При монтаже изделия квалифицированным персоналом необходимо следить за тем, чтобы, поверхность крепления была плоской во всей зоне крепления (без выступающих швов или смещения плитки), структура стен подходила для монтажа изделия и, в частности, не имела слабых мест. Прилагаемые винты и дюбели предназначены только для бетона. При других типах стен необходимо соблюдать указания производителей дюбелей.
- Оптимальное функционирование гарантируется только при использовании в комбинации с ручными душами Hansgrohe и душевыми шлангами Hansgrohe.
- Функционирование и использование ручного душа описано в прилагаемой брошюре.

## **Описание символов**



Не применяйте силикон, содержащий уксусную кислоту.



**Размеры** (см. стр. 17)



**Эксплуатация** (см. стр. 18)



**Очистка**

см прилагаемая брошюра





**Комплект** (см. стр. 20)



**Знак технического контроля**  
(см. стр. 20)

## **Biztonsági utasítások**

-  A szerelésnél a zúzódások és vágási sérülések elkerülése érdekében kesztyűt kell viselni.
-  A terméket nem szabad kapaszkodónak használni. Ehhez külön kapaszkodót kell felszerelni.
-  A zuhanycsövek kizárólag zuhanyok csaptelepekkel való összekötésére alkalmasak. A zuhanycső után (folyásirány szerint) elzárás beszerelése nem engedélyezett!

## **Szerelési utasítások**

- Miközben szakképzett szakember végzi a termék felszerelését, ügyelni kell arra, hogy a rögzítési felületek a rögzítési terület teljes egészén síkok (nincsenek kiálló fugák vagy csempezélek), a fal felépítése alkalmas a termék felszereléséhez, és különösképpen, hogy nincsenek benne gyenge pontok. A mellékelt csavarok és dübelek csak betonhoz alkalmasak. Egyéb falazatoknál figyelembe kell venni a dübelgyártó gyártói utasításait.
- A megfelelő működést csak Hansgrohe kézi zuhanyokkal és Hansgrohe zuhanycsövekkel garantáljuk.
- A kézi zuhany működését és kezelését lásd a mellékelt brosúrában.

## **Szimbólumok leírása**



Ne használjon ecetsavtartalmú szilikon!



**Méretet** (lásd a 17. oldalon)



**Használat** (lásd a 18. oldalon)



**Tisztítás**

lásd a mellékelt brosúrást.



**Tartozékok** (lásd a 20. oldalon)



**Vizsgajel** (lásd a 20. oldalon)

**Монтаж**  
**см. стр. 19**





**Szerelés**  
**lásd a 19. oldalon**





## Turvallisuusohjeet

-  Asennuksessa on käytettävä käsineitä puristumien ja viltojen aiheuttamien tapaturmien estämiseksi.
-  Tuotetta ei saa käyttää kädensijana. On asennettava erillinen kädensija.
-  Suihkuletkut soveltuvat vain käsisuihkun liittämiseen armatuureihin. Letkun jälkeen virtaussuunnassa oleva sulkuventtiili ei ole sallittua!

## Asennusohjeet

- Kun pätevä ammattihenkilöstö suorittaa tuotteen asennusta, on huomioitava, että kiinnityspinta on koko kiinnityksen alueella tasainen (ei ulkonevia saumoja tai laattojen tasomuutoksia) ja, että seinän rakenne soveltuu tuotteen asentamiseen eikä siinä ole heikkoja kohtia. Mukana olevat kiinnitysruuvit ja kiinnitysankkurit soveltuvat betoniin kiinnittämiseen. Kiinnitettäessä tuotetta muihin seinärakenteisiin, noutata kiinnittimien valmistajan ohjeita.
- Optimaalinen toiminta on taattuna vain Hansgrohe käsisuihkuja ja Hansgrohe suihkuletkuja käytettäessä.
- Katso käsisuihkun toiminta ja käyttö mukana olevasta esitteestä.

## Merkin kuvaus



Älä käytä etikahappopitoista silikonia!



**Mitat** (katso sivu 17)



**Käyttö** (katso sivu 18)



**Puhdistus**

katso oheinen esite





**Varaosat** (katso sivu 20)



**Koestusmerkki** (katso sivu 20)

**Asennus  
katso sivu 19**

## Säkerhetsanvisningar

-  Handskar ska bäras under monteringsarbetet så att man kan undvika kläm- och skärskadorgen werden.
-  Produkten får inte användas som handtag. Ett separat handtag måste monteras.
-  Duschslangar är endast avsedda till att ansluta duschar på blandare. Det är inte tillåtet att lägga in en spärr efter slangens och i flödesriktningen!

## Monteringsanvisningar

- När kvalificerad fackpersonal monterar produkten är det viktigt att tänka på att monteringsytan är plan i alla delar av arbetsytan (inga fogar som sticker ut eller klinkerförskjutningar), att väggkonstruktionen passar till montering av produkten samt att den inte har svaga punkter. Medföljande skruvar och plugg är endast avsedda för betong. Vid andra väggkonstruktioner skall anvisningarna från pluggtillverkaren beaktas.
- Optimal funktion garanteras bar tillsammans med Hansgrohe handduschar och Hansgrohe duschslangar.
- Se den medföljande broschyren för information om hur handduschen fungerar och hur den ska hanteras.

## Simbolio aprašymas



Använd inte silikon som innehåller ättiksyra!



**Måtten** (se sidan 17)



**Hantering** (se sidan 18)



**Rengöring**

se den medföljande broschyren



**Reservdelar** (se sidan 20)



**Testsigill** (se sidan 20)



**Montering  
se sidan 19**



## Saugumo technikos nurodymai

- ⚠️ Apsaugai nuo užspaudimo ir įsijovavimo montavimo metu mūvėkite pirštines.
- ⚠️ Gaminy s neturi būti naudojamas kaip rankena. Rankena montuojama atskirai.
- ⚠️ Dušo žarnos yra pritaikytos tik prijungti dušo galvutę prie vandens maišytuvo. Negalima montuoti vandens uždarymo mechanizmo tarp maišytuvo ir žarnos.

## Montavimo instrukcija

- Montuojant produktą, specialistas privalo įsitikinti, kad sienos plotas, prie kurio dedama montavimo plokštė, yra lygus (jokių plytelių ar kitų nelygumų), kad sienos struktūra yra pritaikyta produkto montavimui ir neturi jokių silpnų vietų. Pakuotėje esantys varžtai ir kaiščiai yra skirti tik betonui. Esant kitokiai sienai, varžtus ir kaiščius reikia rinktis pagal paskirtį.
- Optimalus funkcionavimas yra garantuojamas tik naudojant „Hansgrohe“ rankų dušus su „Hansgrohe“ dušo žarnomis.
- Rankinio dušo veikimo ir naudojimo aprašymą rasite pridedamoje brošiūroje.

## Simbolio aprašymas



Nenaudokite silikono, kurio sudėtyje yra acto rūgšties!



**Išmatavimai** (žr. psl. 17)



**Eksplotacija** (žr. psl. 18)



**Valymas**

žr. pridedamoje brošiūroje.



**Atsarginės dalys** (žr. psl. 20)



**Bandymo pažyma** (žr. psl. 20)

## Sigurnosne upute

- ⚠️ Prilikom montaže se radi sprječavanja prignječenja i posjekotina moraju nositi rukavice.
- ⚠️ Proizvod ne smije služiti za pridržavanje. U tu se svrhu mora postaviti zaseban rukohvat.
- ⚠️ Crijeva tuša prikladna su jedino za spajanje tuševa na armature. Nije dopušteno zatvaranje crijeva u smjeru protoka vode!

## Upute za montažu

- Kada proizvod montira kvalificirano stručno osoblje treba paziti da čitava površina na koju se učvršćuje bude ravna (bez istaknutih fuga ili krivljenja pločica), da je zidna konstrukcija primjerena montaži proizvoda te osobito da nema slabih mjesta. Priloženi vijci i moždanici prikladni su samo za beton. Kod drugih zidnih nadgradnji treba obratiti pažnju na navode proizvođača moždanika.
- Optimalno funkcioniranje zajamčeno je jedino u kombinaciji sa Hansgrohe ručnim tuševima i Hansgrohe crijevom za tuš.
- Za rad i opsluživanje ručnog tuša pogledajte priloženu brošuru.

## Opis simbola



Nemojte koristiti silikon koji sadrži octenu kiselinu!



**Mjere** (pogledaj stranicu 17)



**Upotreba** (pogledaj stranicu 18)



**Čišćenje**

se u priloženoj brošuri.



**Rezervni djelovi** (pogledaj stranicu 20)



**Oznaka testiranja** (pogledaj stranicu 20)



**Sastavljanje**  
pogledaj stranicu 19

**Montavimas**  
žr. psl. 19



## ! Güvenlik uyarıları

- ! Montaj esnasında ezilme ve kesilme gibi yaralanmaları önlemek için eldiven kullanılmalıdır.
- ! Ürün tutma kolu olarak kullanılmamalıdır. Aynı bir tutma kolu monte edilmelidir.
- ! Sözü geçen duş boruları, duş parçalarını yalnız donanım takımlarına bağlamaya yarar. Hortumun arkasından sonra akış yönünde kesmek yasaktır!

## Montaj açıklamaları

- Müteahhit, ürünü monteleyeceği yer, yani montaj plakasının monte edileceği duvar alanının tümü düz (herhangi bir eklem yerinin ya da duvar fayansının çıkıntısıyla) engellenmemiş, yapısı ürünü montelemeye uygun bir şekilde ve herhangi zayıf noktası olamamasını sağlamalıdır. Kaplı vidalar ve çubuklar sadece beton için uygundur. Başka duvar yapıları için, imalatçının çubuk imal edenini belirttiği hususlar dikkate alınmalıdır.
- Mümkün olduğu kadar iyi işlev, yalnız Hansgrohe elle duş parçaları ve Hansgrohe duş boruları kullanılırsa, garanti edilir.
- El duşunun işlevi ve kullanımı için birlikte verilen broşüre bakınız.

## Simge açıklaması



Asetik asit içeren silikon kullanmayın!



**Ölçüleri** (Bakınız sayfa 17)



**Kullanımı** (Bakınız sayfa 18)



**Temizleme**

birlikte verilen broşür



**Yedek Parçalar** (Bakınız sayfa 20)



**Kontrol işareti** (Bakınız sayfa 20)

## ! Instrucțiuni de siguranță

- ! La montare utilizați mânășu pentru evitarea contuziunilor și tăierii mâinilor.
- ! Nu este permisă utilizarea produsului pe post de mâner. este nevoie de montarea unui mâner corespunzător.
- ! Furtunul de duș poate fi utilizat numai pentru conectarea telefonului de duș la baterie. Nu este permisă montarea unui opritor la capătul furtunului!

## Instrucțiuni de montare

- La montarea produsului de către un personal calificat trebuie să fiți atenți ca suprafața, unde se fixează produsul să fie plată pe toată suprafața utilizată (să nu existe rosturi sau faianțe proeminente), peretele să fie adecvat pentru montarea produsului și să nu există zone de rezistență redusă. Șuruburile și diblurile livrate sunt potrivite pentru ziduri de beton. La alte tipuri de zid respectați instrucțiunile producătorului diblului utilizat.
- Funcționarea optimă este garantată numai când este conectat la duș de mână și furtun de duș marca Hansgrohe.
- Pentru funcționarea și operarea telefonului de duș vezi broșura alăturată.

## Descrierea simbolurilor



Nu utilizați silicon cu conținut de acid acetic!



**Dimensiuni** (vezi pag. 17)



**Utilizare** (vezi pag. 18)



**Curățare**

vezi broșura alăturată.



**Piese de schimb** (vezi pag. 20)



**Certificat de testare** (vezi pag. 20)

**Montați**  
**Bakınız sayfa 19**



**Montare**  
**vezi pag. 19**



## Υποδειξεις ασφαλείας

- ⚠ Για να αποφύγετε τραυματισμούς κατά τη συναρμολόγηση πρέπει να φοράτε γάντια.
- ⚠ Το προϊόν δεν επιτρέπεται να χρησιμοποιείται σαν λαβή στήριξης. Για τον σκοπό αυτό πρέπει να τοποθετηθεί ξεχωριστή λαβή στήριξης.
- ⚠ Το εύκαμπο σπирάλ του καταιονιστήρα είναι κατάλληλο μόνο για τη σύνδεση του καταιονιστήρα χειρός με τη βάνα. Δεν επιτρέπεται καμία στρόφιγγα διακοπής μετά το σωλήνα στην κατεύθυνση ροής!

## Οδηγίες συναρμολόγησης

- Κατά τη συναρμολόγηση του προϊόντος από καταρτισμένο και εξειδικευμένο προσωπικό θα πρέπει να δοθεί προσοχή, ώστε η επιφάνεια στερέωσης στη συνολική περιοχή στερέωσης να είναι επίπεδη (να μην υπάρχουν προεξέχοντες αρμοί ή λιθογόμωση πλακιδίων), ώστε η κατασκευή του τοίχου να είναι κατάλληλη για τη συναρμολόγηση του προϊόντος και ώστε η επιφάνεια να μην παρουσιάζει αδύναμα σημεία. Οι συνημμένες βίδες και οι στυλισκοί ενδείκνυται μόνο για σκυρόδεμα. Σε άλλες επίτοιχες κατασκευές θα πρέπει να δοθεί προσοχή στα δεδομένα του Κατασκευαστή των στυλισκών.
- Εγγύηση βέλτιστης λειτουργίας μόνο σε συνδυασμό με καταιονιστήρα χειρός Hansgrohe και σπирάλ Hansgrohe.
- Για τη λειτουργία και τον χειρισμό του τηλεφώνου ντους βλέπε συνημμένο ενημερωτικό φυλλάδιο.

## Περιγραφή συμβόλων



Μην χρησιμοποιείτε σιλικόνη που περιέχει οξικό οξύ!



**Διαστάσεις** (βλ. σελίδα 17)



**Χειρισμός** (βλ. σελίδα 18)



**Καθαρισμός**

βλ. συνημμένο φυλλάδιο



**Ανταλλακτικά** (βλ. σελίδα 20)



**Σήμα ελέγχου** (βλ. σελίδα 20)

**Συναρμολόγηση**  
**βλ. σελίδα 19**



## Varnostna opozorila

- ⚠ Lors du montage, porter des gants de protection pour éviter toute blessure par écrasement ou coupure.
- ⚠ Proizvoda ne smete uporabljati kot drzalnega rocaja. V ta namen je treba montirati poseben rocaj.
- ⚠ Gibke cevi za prho so primerne le za povezavo prhe in armature. Naprave za zapiranje pretoka vode nikoli ne nameščajte med armaturo in cev.

## Navodila za montažo

- Kamorkoli bo pogodbjenik namestil izdelek, mora poskrbeti, da je celotno območje stene na katero bo plošča nameščena ravno (brez štrlečih fug ali robov ploščic), ter da je struktura stene primerna za namestitev in je brez šibkih točk. Priloženi vijaki in ležaji so primerni le za beton. Za ostale zidne konstrukcije je potrebno upoštevati proizvajalčeva navodila.
- Optimalno delovanje je zagotovljeno le v povezavi z ročnimi prhami Hansgrohe in gibkimi cevmi za prho Hansgrohe.
- Delovanje in uporabo ročne prhe glejte v priloženi brošuri.

## Opis simbola



Ne smete uporabiti silikona, ki vsebuje ocatno kislino!



**Mere** (glejte stran 17)



**Upravljanje** (glejte stran 18)



**Čiščenje**

glejte priloženi brošuri.



**Rezervni deli** (glejte stran 20)





**Preskusni znak** (glejte stran 20)

**Montaža**  
**Glejte stran 19.**



## Ohutusjuhised

-  Kandke paigaldamisel muljumis- ja löikevigastuste vältimiseks kindaid.
-  Toodet ei tohi kasutada käepidemena. Paigaldage eraldi käepide.
-  Dušivoolikud sobivad üksnes duši ühendamiseks segistitega. Mingil juhul ei tohi vooliku ja segisti vahele asetada sulgurit.

## Paigaldamisjuhised

- Toote paigaldamisel peab töövõtja tagama, et kogu seinapind, kuhu paigaldusplaat kinnitatakse, on lame (ükski vuuk ega keraamiline plaat ei ulatu esile), ning et seina konstruktsioon on toote paigaldamiseks sobiv ja sellel puuduvad nõrgad kohad. Kaasasolevad kruvid ja tüüblid sobivad üksnes betoonile. Muude seinakonstruktsioonide puhul tuleb arvesse võtta tüüblitootja esitatud tooteandmeid.
- Optimaalne funktsioneerimine on garanteeritud ainult koos Hansgrohe käsiduššide ja Hansgrohe dušivoolikutega.
- Käsiduši talitlust ja kasutamist vaata kaasasolevast brošüürist.

## Sümbolite kirjeldus



Ärge kasutage äädikhapet sisaldavat silikooni!



**Mõõtude** (vt lk 17)



**Kasutamine** (vt lk 18)



**Puhastamine**

vt kaasasolevast brošüürist.





**Varuosad** (vt lk 20)



**Kontrollsertifikaat** (vt lk 20)

**Paigaldamine**  
vt lk 19

## Drošības norādes

-  Montāžas laikā, lai izvairītos no saspiedumiem un iegriezumiem, nepieciešams nēsāt cimdus.
-  Šo produktu nedrīkst izmantot kā roku balstu. Nepieciešams uzmontēt atsevišķu roku balstu.
-  Dušas šļūtenes ir piemērotas tikai dušas pieslēgšanai pie jaucējkraņa. Nepieļaujama ir noslēgarmatūras pievienošana aiz šļūtenes plūsmas virzienā!

## Norādījumi montāžai

- Ja izstrādājuma montāžu veic kvalificēti speciālisti, jāseko, lai nostiprināšanas virsma visā nostiprināšanas zonā būtu gluda (šuves un flīzes nav izvīrītas uz āru), lai sienas konstrukcija būtu piemērota izstrādājuma montāžai un būtu pietiekami izturīga. Komplektā esošās skrūves un dībeļi ir paredzēti tikai šī izstrādājuma nostiprināšanai. Ja sienas konstrukcija ir citāda, jāievēro dībeļu ražotāja norādījumi.
- Optimāla funkcija tiek garantēta tikai kombinācijā ar Hansgrohe rokas dušām un Hansgrohe dušas šļūtenēm.
- Rokas dušas funkciju un lietošanu skatiet pievienotajā brošūrā.

## Simbolu nozīme



Neizmantojiet silikonu, kas satur etiķskābi!



**Izmērus** (skat. 17. lpp.)



**Lietošana** (skat. 18. lpp.)



**Tīrīšana**

skatiet pievienotajā brošūrā.



**Rezerves daļas** (skat. 20. lpp.)



**Pārbaudes zīme** (skat. 20. lpp.)



**Montāža**  
skat. 19. lpp.



### ! Sigurnosne napomene

- ⚠ Prilikom montaže se radi sprečavanja prignječenja i posekotina moraju nositi rukavice.
- ⚠ Proizvod se ne sme koristiti za kao ručka za pridržavanje. U tu svrhu se mora postaviti zaseban rukohvat.
- ⚠ Creva tuša prikladna su jedino za spajanje tuševa na armature. Nije dopušteno blokiranje creva u smeru protoka vode!

### Instrukcije za montažu

- Kada proizvod montira kvalifikovano stručno osoblje treba paziti da čitava površina na koju se učvršćuje bude ravna (bez istaknutih fuga ili krivljenja pločica), da je zidna konstrukcija primerena montaži proizvoda, i posebno da nema slabih mesta. Priloženi zavrtnji i tiplovi prikladni su samo za beton. Kod drugih zidnih nadgradnji treba obratiti pažnju na navode proizvođača tiplova.
- Optimalno funkcionisanje je garantovano jedino u kombinaciji sa Hansgrohe ručnim tuševima i Hansgrohe crevom za tuš.
- Za rad i opsluživanje ručnog tuša pogledajte priloženu brošuru.

### Opis simbola



Nemojte koristiti silikon koji sadrži sirćetnu kiselinu!



**Mere** (vidi stranu 17)



**Rukovanje** (vidi stranu 18)



**Čišćenje**

vidi priloženoj brošuri.



**Rezervni delovi** (vidi stranu 20)



**Ispitni znak** (vidi stranu 20)

### ! Sikkerhethenvisninger

- ⚠ Bruk hansker under montasjen for å unngå klem- og kuttskader.
- ⚠ Produktet skal ikke brukes som holdegrep. Det skal monteres en separat holdegrep.
- ⚠ Dusj slanger er kun egnet for tilkobling av dusj til armaturer. Det er ikke tillatt med en avsperring etter slangen i gjennomstrømningsretning!

### Montagehenvisninger

- Når kvalifisert fagfolk monterer produktet, skal man påse at hele området der produktet monteres er plant (ingen fremstående fuger eller flisekanter), at oppbygging av veggen er egnet for montasje av produktet og at veggen ikke viser noen svakpunkter. Medleverte skruer og plugg er egnet seg kun for betong. Ved en annen veggoppbygging skal man ta hensyn til pluggprodusentens henvisninger.
- Optimal funksjon garanteres kun i forbindelse med Hansgrohe hånddusj og Hansgrohe dusjslanger.
- Se vedlagt brosjyre for funksjon og betjening av hånddusjen.

### Symbolbeskrivelse



Ikke bruk silikon som inneholder eddiksyre!



**Mål** (se side 17)



**Betjening** (se side 18)



**Rengjøring**

se vedlagt brosjyre.



**Servicedeler** (se side 20)





**Prøvemerk** (se side 20)





## Указания за безопасност

-  При монтажа трябва да се носят ръкавици, за да се избегнат наранявания поради притискане или порязване.
-  Продуктът не бива да се използва като дръжка. Трябва да се монтира отделна дръжка.
-  Маркучите на разпръсквателите са подходящи само за свързване на разпръскватели към арматури. Не се допуска блокиране след маркуча по посоката на протичане!

## Указания за монтаж

- При монтаж на продукта от квалифицирани специалисти да се внимава за това, закрепващата повърхност в целия диапазон на закрепването да бъде равна (без изпъкнали fugи или изместване на плочки), конструкцията на стената да е подходяща за монтаж на продукта и особено за това, да няма слаби места. Приложените винтове и дюбели са подходящи само за бетон. При други стени конструкции да се спазват данните на производителя на дюбели.
- Оптималното функциониране се гарантира само във връзка с ръчните разпръскватели и маркучите на разпръсквателите на Hansgrohe.
- Вижте функцията и обслужването на ръчния разпръсквател от приложената брошура.

## Описание на символите

 Не използвайте силикон, съдържащ оцетна киселина!

 **Размери** (вижте стр. 17)

 **Обслужване** (вижте стр. 18)



 **Почистване**  
от приложената брошура.

 **Сервизни части** (вижте стр. 20)

 **Контролен знак** (вижте стр. 20)

**Монтаж**  
**вижте стр. 19**

## Udhëzime sigurie

-  Për të evituar lëndimet e pickimeve ose të prerjeve gjatë procesit të montimit duhet që të vishni doreza.
-  Produkti nuk duhet të përdoret si dorëze mbajtëse. Duhet të montohet një dorëzë mbajtëse e veçantë
-  Zorra e dushit mund të përdoren vetëm për lidhjen e spërkatëseve me armaturën. Ndalohet bllokimi pas zorrës në drejtim të rrjedhjes!

## Udhëzime për montimin

- Gjatë montimit të produktit nga ana e personit të kualifikuar duhet pasur parasysh që e gjithë sipërfaqja mbërthyesë të jetë e drejtë (nuk duhet të ketë hapësira mes pllakave). Mbi të gjitha muri duhet të jetë i përshtatshëm për montim dhe nuk duhet të ketë pika të dobëta. Vidhat dhe kunjat e bashkangjitura janë të përshtatshme vetëm për beton. Te përbërja tjetër murore të merren parasysh të dhënat e prodhuesit të kunjave.
- Garantohet funksioni optimal vetëm në kombinim me spërkatëset Hansgrohe si dhe zorrat e dushit Hansgrohe.
- Për funksionimin dhe përdorimin e dushit shikoni broshurën bashkëngjitur.

## Përshkrimi i simbolit

 Mos përdorni silikon që në përbërje ka acid acetik.

 **Përmasat** (shih faqen 17)

 **Përdorimi** (shih faqen 18)

 **Pastrimi**  
shikoni broshurën bashkëngjitur.

 **Pjesë ndërrimi** (shih faqen 20)

 **Shenja e kontrollit** (shih faqen 20)

**Montimi**  
**shih faqen 19**





## تنبيهات الأمان



⚠ يجب إرتداء قفازات لليد أثناء التركيب لتجنب حدوث أضرار الإنحشار أو الجروح.

⚠ ممنوع إستخدام المنتج كمقبض. يجب تركيب مقبض منفصل.

⚠ لا تصلح خراطيم الدش إلا للتوصيل من الدش إلى الوصلة. حذار من تركيب جهاز إغلاق بين الوصلة والخراطوم.

## تعليمات التركيب

- يجب الانتباه عند تركيب المنتج بواسطة فريق العمل المتخصص إلى أن جميع مواضع التثبيت جاهزة للتثبيت دون عوائق (خالية من المفصلات أو الملصقات)، وأن الحائط جاهز لتركيب المنتج مع عدم احتوائه على أية أماكن ضعيفة. مبيئات المسامير (الفيشر) والمسامير نفسها مناسبة للحوائط الخرسانية فقط، ويجب الالتزام بتعليمات الجهة المصنعة لمبيئات المسامير عند التثبيت في أنواع أخرى من الحوائط.
- لا يمكن ضمان الحصول على الأداء الأمثل إلا من خلال الجمع بين الدش اليدوي إنتاج هانز جروهه وخراطيم الدش إنتاج هانز جروهه.
- للاطلاع على وظيفة وتشغيل الدش اليدوي، انظر الكتيب المرفق.

## وصف الرمز

هام! لا تستخدم السليكون الذي يحتوي على أحماض!



أبعاد (راجع صفحة 17)



التشغيل (راجع صفحة 18)



## التنظيف

راجع والكتيب المرفق



قطع الغيار (راجع صفحة 20)



شهادة اختبار (راجع صفحة 20)







**Unica'Crometta**

27609000

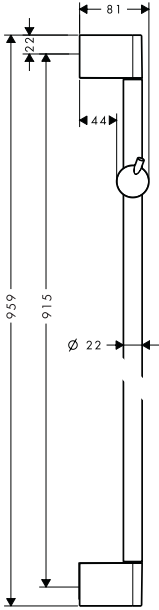

**Unica'Crometta**

27614000

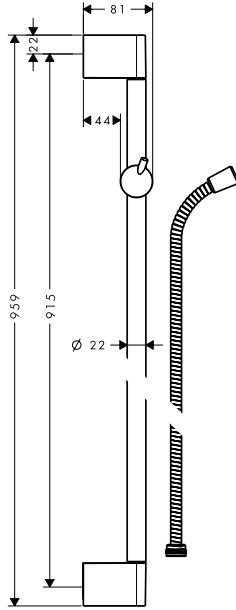

**Unica'Crometta**

27615000

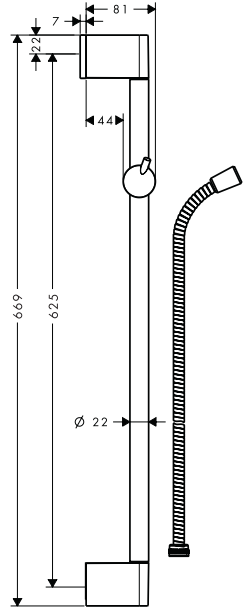

**Crometta 85 1jet/Unica'Crometta Set**

27729000

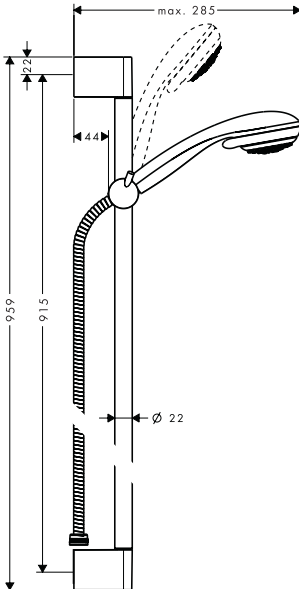

**Crometta 85 1jet/Unica'Crometta Set**

27728000

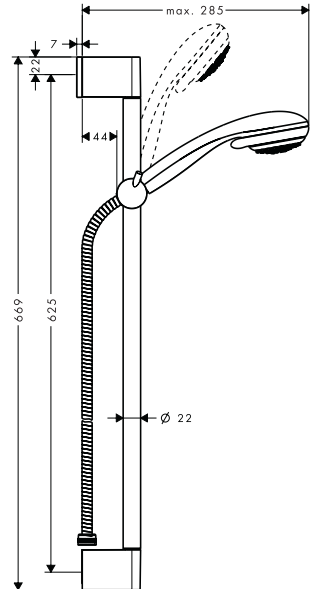

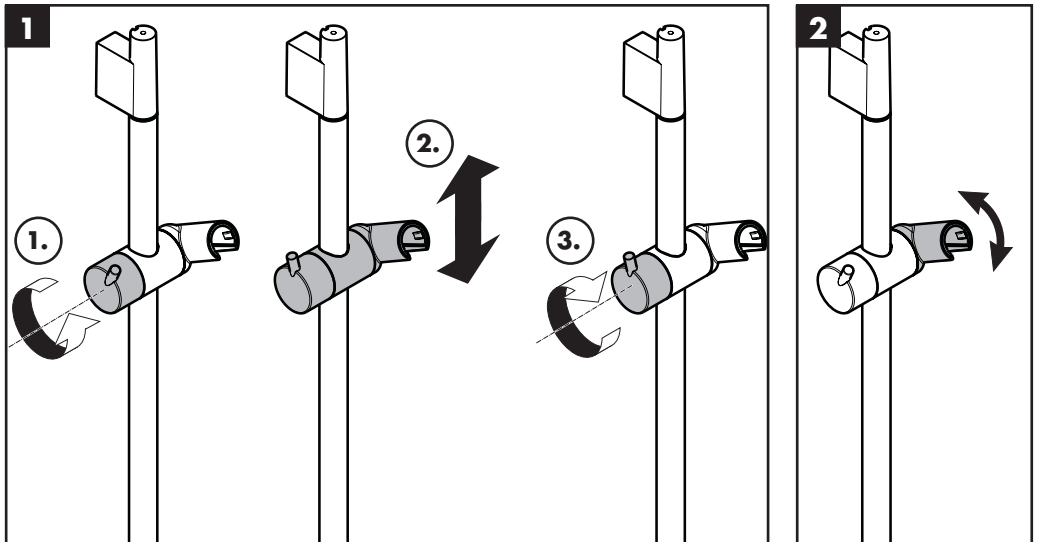
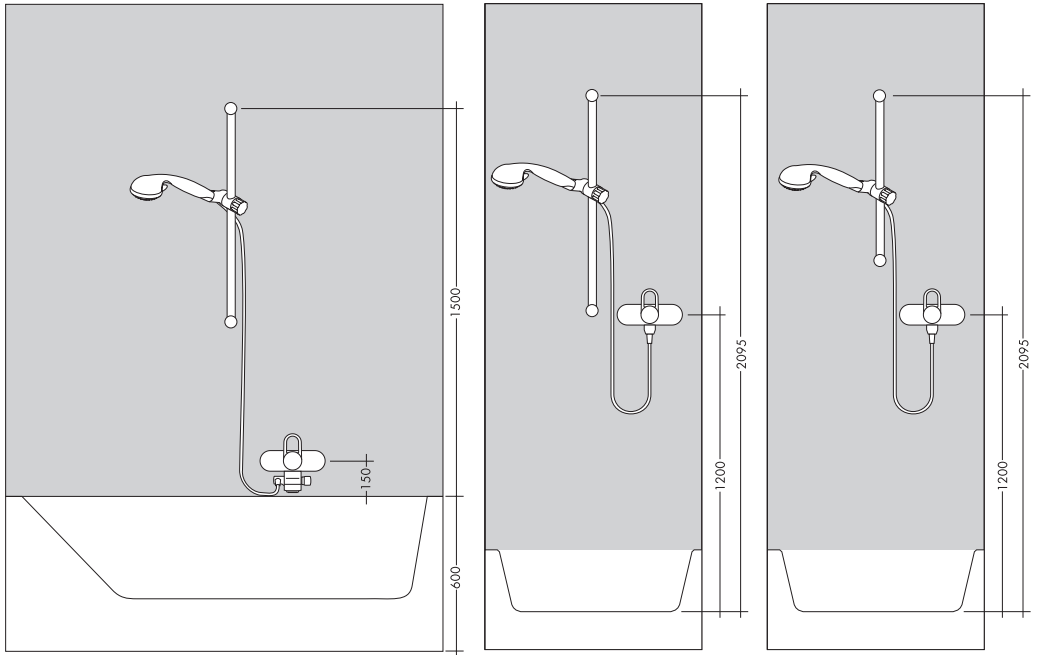

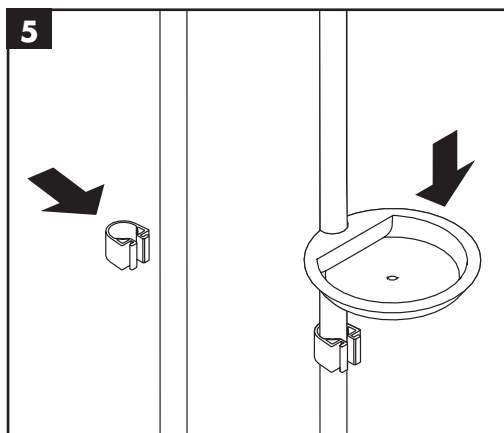
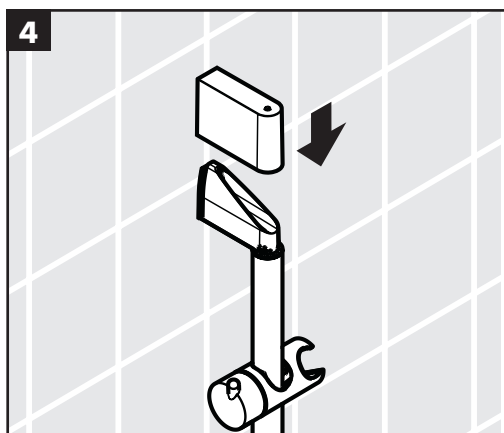
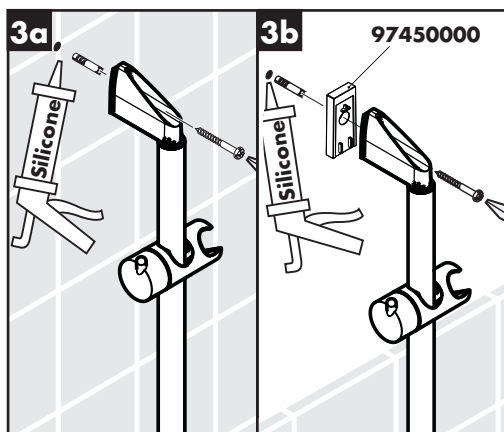
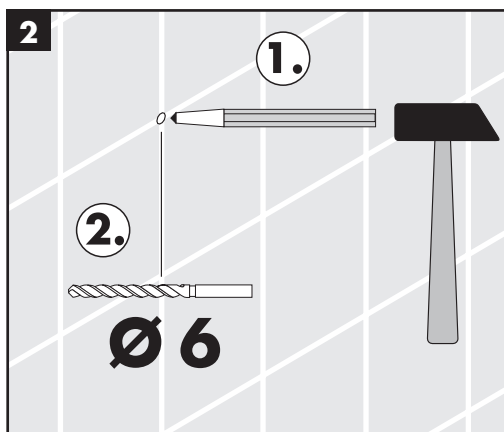
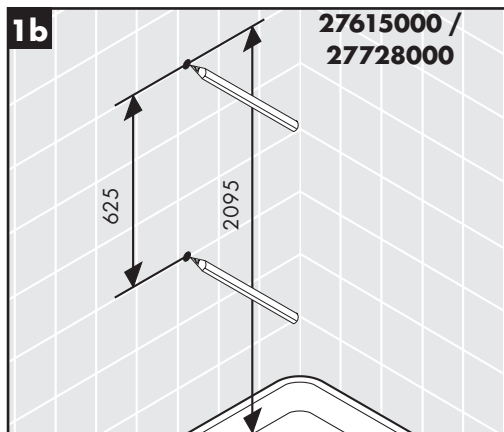
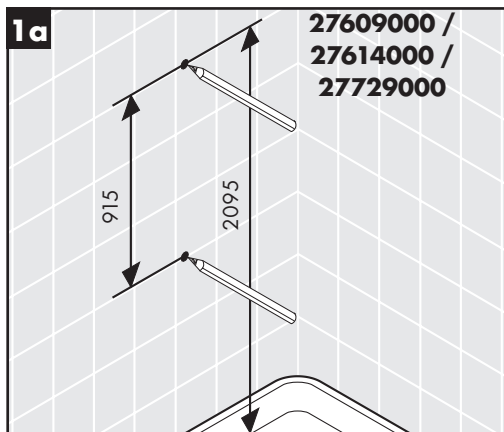

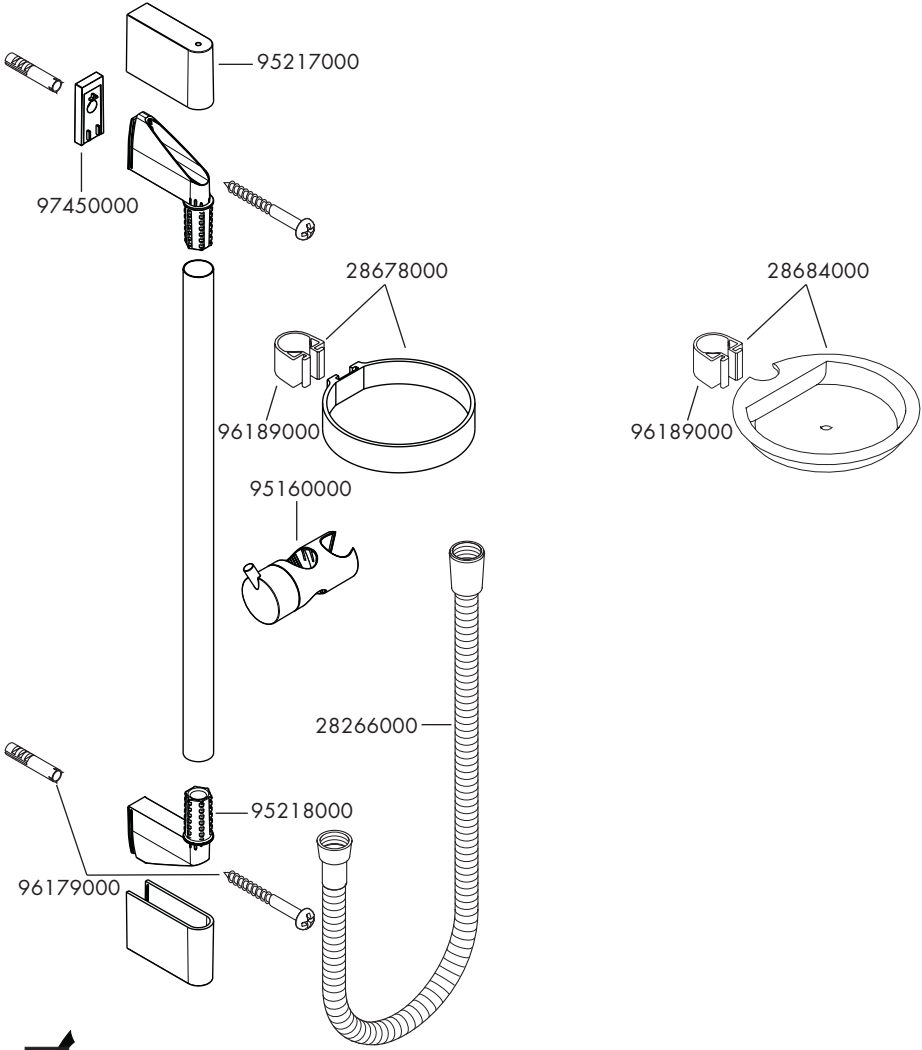

P-IX

DVGW

SVGW

WRAS KIWA

NF

ACS

ETA

27615000

X

**hansgrohe**

Hansgrohe - Postfach 1145 · D-77761 Schiltach · Telefon +49 (0) 78 36/51-1282 · Telefax +49 (0) 7836/511440  
E-Mail: info@hansgrohe.com · Internet: www.hansgrohe.com

05/2011  
9.01759.01